

Model

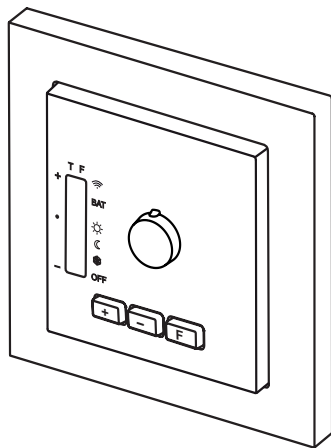

ST01E5001-01

Technical details

Frequency:	868.30 MHz
Radiated power:	4.47 mW
Modulation:	FSK
Coding:	Easywave POTA
Range	free-field: approx. 150 m buildings: approx. 30 m
Operating temperature:	-20 °C to +40 °C
Control range:	approx. +14 °C to +25 °C
Measuring cycle:	once per minute
Power supply:	2x 3V-batteries, CR2032
Dimensions (w/l/h):	
Cover	55/55/16.0 mm
Mounting plate	71/71/1.8 mm
Cover frame	80/80/9.4 mm
Weight:	51 g (incl. batteries and cover frame)

Scope of delivery

Transmission module, 2 batteries CR2032, cover, mounting plate, cover frame, adhesive pad, operating instructions

Intended use

The radio thermostat may only be used to measure the ambient temperature and to operate Easywave radio receivers.

The manufacturer shall not be liable for any damage caused by improper or non-intended use!

Safety instructions

 Please read the operating instructions carefully before using the device!

- Also read the operating instructions for the devices to be controlled! Do not modify the devices!
- Have faulty hand transmitters checked by the manufacturer!
- Keep the batteries away from children!
- Keep the packing away from children!

Function

The temperature sensor ST01 is a battery-operated radio thermostat for indoor use. Detected deviations from the setpoint are sent via Easywave radiogram to radio receivers which are connected to a heating system. That way, the temperature can be controlled between approx. 14 °C and approx. 25 °C via radiogram.



The ST01 can be operated in the control mode ON/OFF or PWM optionally. These control modes determine the intervals in which radiograms will be sent:

ON/OFF (I/O): If the measured temperature is above the set target value, the heating is switched off. If the actual value is below the target value, the heating is switched on.

The ST01 sends a status telegram with the current switching state every 4 hours in order to not trigger the emergency switching of the corresponding receivers (e.g. RCJ15 and RCP22). This also happens when the ST01 is turned off (OFF).

PWM (Pulse width modulation, only with compatible receivers possible): PWM is an adaptive control mode. The temperature sensor analyzes the heating behaviour and sends switching commands in larger time intervals. This extends the battery life.

You can select three different operating modes on the temperature sensor: day operation, night setback and anti-freeze. You can also turn off the temperature sensor entirely.

-  In the operating mode **day operation**, you can save room temperature setpoints for the desired day room temperature permanently.
-  In the operating mode **night setback**, you can save room temperature setpoints for the desired night room temperature permanently.
-  In **anti-freeze mode**, the temperature remains constantly around the freezing point in order to prevent pipes from freezing.
- OFF No temperature control at OFF. The status code B (OFF) is transmitted every 4 hours.

The temperature sensor is delivered with the following settings:

- Control mode I/O
- Operating mode day operation
- Setpoint room temperature 20 °C.

Start-Up

1. **Insert the batteries**
Insert the included batteries into the transmitter module.
Make sure the polarity is correct! The positive pole has to be visible!

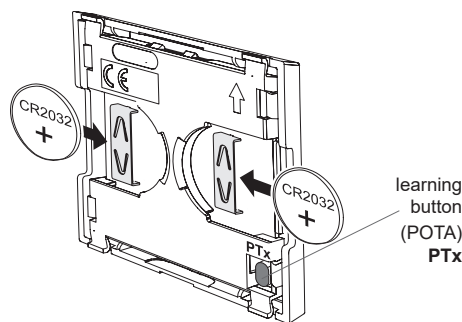

2. **Program ST01 into the receiver and select temperature**
 1. Put the receiver into programming mode. Please read the operating instructions supplied with the receivers.
 2. Press the **+** button or **-** button on the sensor to send a telegram. The Easywave Code **A (+)** or **B (-)** will be sent. For this operation the sensor must be in the operating mode. All LEDs must be off.
→ the radio symbol  on the sensor lights up briefly (2 s) and the transmitter has been programmed into the receiver



3. Press the **+** / **-** buttons again to set the temperature setpoint.
4. Do not press any button for 10 seconds. The sensor switches to operating mode, the set target value is saved and the LEDs are off.

3. Mount the sensor

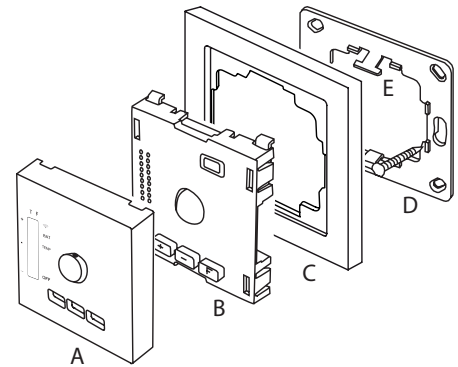
1. Screw or stick the mounting plate (D) to the installation site.
2. Put the cover frame (C) on the mounting plate (D).
3. Lock the transmission module (B) on the catches (E) and mount the cover (A).



Displaying/setting the operat. mode

1. Press the **F** button to switch between the operating modes  /  /  / OFF.
→ the LED in the right column (F) displays the operating mode of the sensor
→ the LED in the left column (T) displays the current temperature and the temperature setpoint
2. Do not press a button for 10 seconds to save the settings, the LED goes off.

Setting the control mode

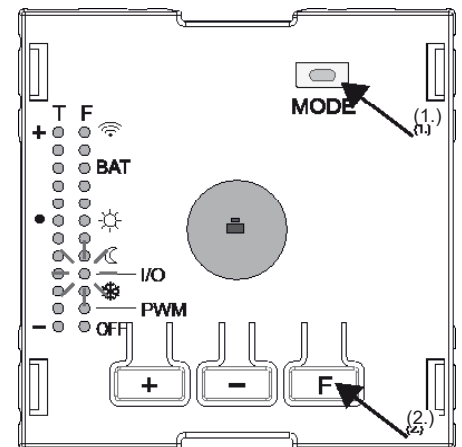

1. Remove cover (A) and press **MODE** button. The current mode is displayed for 10 s.
2. Within the 10 seconds, press the **F** button to switch between PWM and I/O.
3. Do not press a button for 10 s.
→ the LED goes off and the sensor returns from setup mode to control mode
→ the settings have been saved.

 The saved control mode remains even after a battery change.

Operation overview

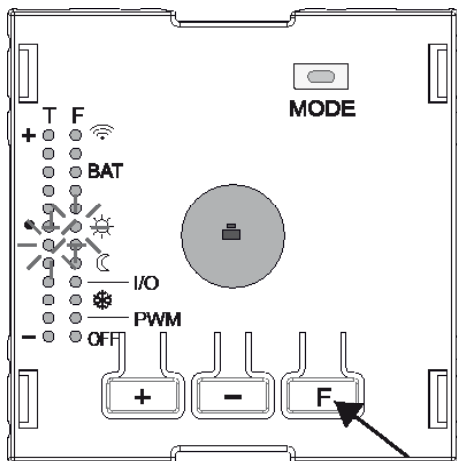

Temperature settings (T)

- Button
- +** increase setpoint
 - reduce setpoint

Current value
LED lights up

Setpoint
LED blinks

max. value approx. 25 °C →

min. value approx. 14 °C →

Function settings (F)

- Button
- F** Set operation mode

LED blinks: radio telegram is transmitted.

LED flashes every minute: battery almost empty

Operating modes (MODE) Control modes

- Day operation
- Night setback
- Anti-freeze
- LED lights: Sensor is deactivated
- ON/OFF
- Pulse width modulation

- +** Button **+**: increase target value
Easywave code A is sent
LED **T**: display temperature values
- Button **-**: reduce target value
Easywave code B is sent
LED **T**: display temperature values
- F** Button **F**: activate setup mode
setting the operating mode (OM)
LED **F**: display CM or OM

Operation [press the button]	LED display	Comment
Programming sensor into the receiver		
1. Put the receiver into programming mode.		Please read the operating instructions of the receiver.
2. Button + or Button -	LED F lights up briefly	The Easywave code A (+) or B (-) is transmitted and programmed into the receiver. Only possible when the device is in standby mode (all LEDs off)!
3. wait 10 seconds	LEDs OFF	The sensor changes to the operating mode.
Setting the control mode (CM)		
1. Button MODE	LED F current CM lights up	Control mode can be set for 10s.
2. Button F	LED F new CM lights up	Select control mode by pressing repeatedly.
3. wait 10 seconds	LEDs OFF	Last selected control mode saved.
Setting the operating mode (OM) / deactivate sensor / / / OFF		
1. Button F	LED F current OM lights up	Sensor is in setup mode for 10 seconds, the operating mode can be selected.
2. Button F	LED F new OM lights up	Press repeatedly to change operating mode or switch the sensor off (OFF)
3. wait 10 seconds	LEDs OFF	Last selected operating mode active.
Setting/change the setpoint		
1. Button F	LED F current OM lights up	Sensor is in setup mode for 10 seconds. If necessary, change the operating mode by pressing repeatedly.
2. Button + or Button -	LED T current value lights up LED T setpoint blinks	Set the desired setpoint for the selected operating mode by repeatedly pressing.
3. wait 10 seconds	LEDs OFF	The new setpoint is saved, the selected operating mode is set and the code A (ON) or code B (OFF) is transmitted accordingly.

Remote learning (POTA)

The ST01 has the remote learning function POTA (Programming Over The Air).

This can be used to reprogram an already-installed and no longer accessible receiver, as long as the ST01 is programmed into it. To find out whether a specific receiver supports this function, please refer to its operating instructions.

A detailed POTA programming manual is available on our website:

https://www.eldat.de/pota_en.pdf

or you can request support from our customer service

Battery check

The battery check function of the ST01 checks the battery voltage during the transmission procedure.

If the battery capacity is low, the battery indicator **BAT** flashes briefly once per minute. Change the batteries now.

At the end of the transmission process, an undervoltage telegram is transmitted automatically. This telegram can be evaluated by compatible Easywave receivers. For further information on this, please refer to the operating instructions of the corresponding receiver.

General information

Disposal

Waste electrical products and batteries may not be disposed of with household waste!

Dispose of the waste product via collection facilities for electronic scrap or via your specialist dealer.



Dispose of used batteries in a recycling bin for batteries or via the specialist trade.



Dispose of packaging material in the recycling bins for cardboard, paper and plastic.

Troubleshooting

The receiver does not react to the temperature sensor:

- Replace the batteries, if necessary.
- Check that the radio link between the sensor and the receiver at the installation site is not impaired.
- Reprogram the sensor into the radio receiver, if necessary.
- Other wireless devices using the same frequency and working in direct proximity may interfere with the device.

Temperature changes do not appear immediately:

- The measuring cycle of 1 minute is not complete.
- If the temperature changes too much, because of the temperature behavior of the sensor materials, the real temperature is displayed with a delay.

Warranty

Within the statutory warranty period we undertake to rectify free of charge by repair or replacement any product defects arising from material or production faults. Any unauthorized tampering with, or modifications to, the product shall render this warranty null and void.

Conformity

Hereby, ELDAT Eas GmbH declares that the radio equipment type ST01 is in compliance with Directive 2014/53/EU. The full text of the EU declaration of conformity is available at the following internet address: www.eldat.de



Customer service

If the device does not work properly despite proper handling or in case of damage, please contact the manufacturer or your retailer.

ELDAT Eas GmbH

Schmiedestraße 2
15745 Wildau
Germany

Phone: +49 3375 9037-310

Internet: www.eldat.de

E-mail: info@eldat.de